

Data Sheet



Article number: 259608003050

Description: Flange B5
for Bonfiglioli motor size BN 80

Measures

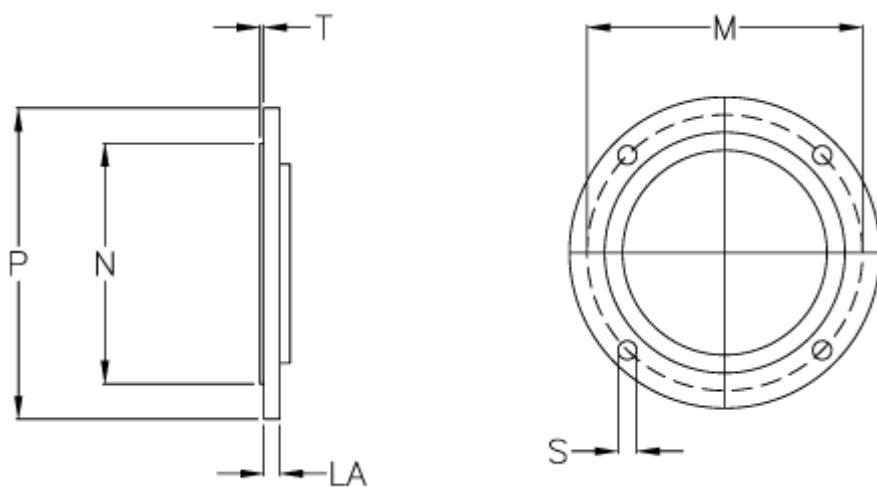

LA = 11.5

M = 165

N = 130

P = 200

S = 11,5

Size = BN 80 B5

T = 3.5